

# Astro2010 Technology White Paper: Coherent Detector Arrays for Millimeter and Submillimeter Astronomy

Paul F. Goldsmith ([Paul.F.Goldsmith@jpl.nasa.gov](mailto:Paul.F.Goldsmith@jpl.nasa.gov) 818-393-0518)  
*Jet Propulsion Laboratory, California Institute of Technology*

John Carpenter (CIT), Neal Erickson (UMass), Rick Fisher (NRAO), John Ford (NRAO), Todd Gaier (JPL), Chris Groppi (UAz), Andy Harris (UMd), Mark Heyer (UMass), Craig Kulesa (UAz), Charles Lawrence (JPL), Matt Morgan (NRAO), Lee Mundy (UMd), Gopal Narayanan (UMass), Karen O'Neil (NRAO), Tony Readhead (CIT), Lorene Samoska (JPL), Peter Schloerb (UMass), Ron Snell (UMass), Christopher Walker (UAz), & Lucy Ziurys (UAz)

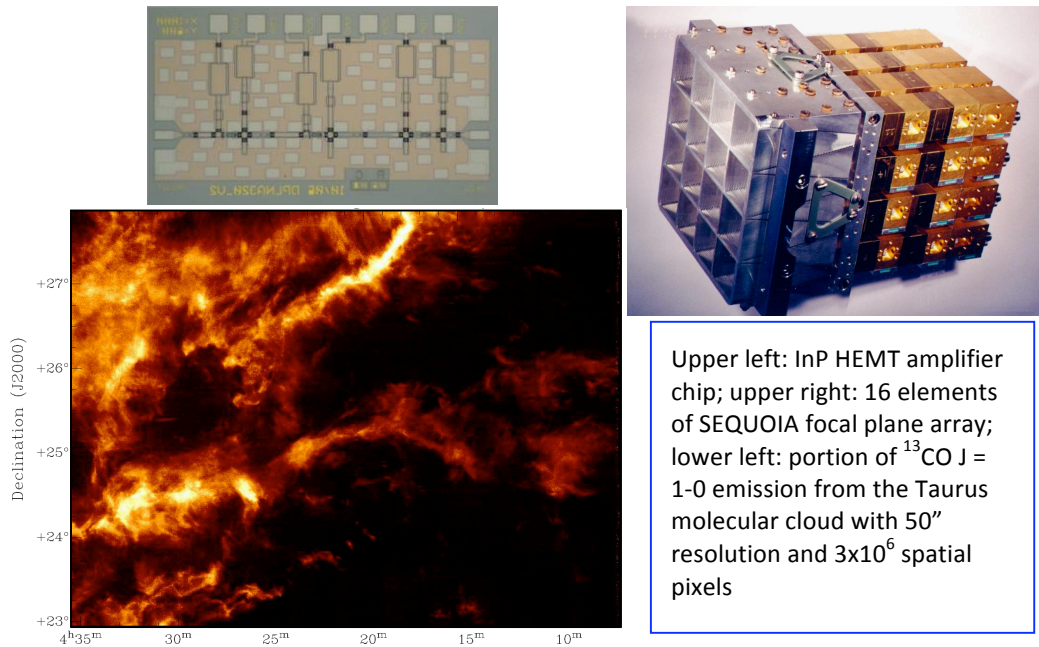

## Abstract

Progress in many areas of astronomy requires large-area surveys and observations of extended objects. This includes the cosmic microwave background, nearby galaxies, the Milky Way, and regions of star-forming regions within our galaxy. The ability to carry out such studies is critically dependent on the development of affordable high-sensitivity focal plane arrays, for both spectral line and continuum observations. We discuss a program for the next decade to develop such technology for ground-based and space-based millimeter and submillimeter astronomy. Appropriate technologies exist, but significant effort is required to make the transition from simply replicating individual pixels to approaching focal plane array design in an integrated fashion from feeds to spectrometers for spectral analysis. This advance is essential to realize the full potential of major new ground-based, suborbital, and future space facilities, and is relevant to the RMS and EOS panels. The recommended budget for this activity is \$65M.

## Introduction

Astronomical information comes on a range of angular sizes. For example, to comprehend the structure of a nearby galaxy, we must cover an object many arcminutes in angular size, but would like to have angular resolution of a few arcseconds or better. Radio astronomy has pioneered the development of interferometry to achieve exquisite angular resolution, and ALMA will soon offer dramatic enhancements in this area. Radio astronomy has lagged behind other fields of astronomy in terms of imaging over large areas with good angular resolution. It is only with the advent of large millimeter and submillimeter antennas that the angular resolution of a single element is high enough to attack important astronomical problems. At the same time, the most interesting observations are often directed at very extended regions, which cannot be covered in a reasonable time by a telescope equipped with a single pixel detector. This is even more the case for ground-based submillimeter observations where system sensitivities are lower and atmospheric variability puts a premium on efficient use of good weather. Suborbital and space-based systems are so expensive that a focal plane array can be immediately justified if one can be built with the required pixel sensitivity and system requirements.

A strength of radio astronomy has been the use of coherent detectors, with which it is straightforward to achieve diffraction-limited operation of a telescope and high spectral resolution sufficient to resolve spectral lines even in the most quiescent regions. In extending these capabilities to focal plane arrays, we have to deal with multiple spectrometers, with each pixel producing hundreds to tens of thousands of spectral channels of information. The complexity of coherent arrays means that the extension from a single pixel to an array results in new technical challenges that while not “fundamental”, must be overcome to have practical systems. Focal plane arrays developed to date have already demonstrated dramatic gains in terms of astronomical data quality and observing efficiency. They have, however, been limited to relatively small number of pixels (32 in an operational spectroscopic array). This can hardly stand comparison with infrared and optical arrays with sizes measured in megapixels. To obtain radio and submillimeter arrays with hundreds to thousands of pixels, replicating individual elements is not satisfactory: a higher level of integration is required, as is routine at shorter wavelengths.

This document addresses focal plane array technology that will allow efficient use of new ground-based, suborbital, and anticipated space facilities for millimeter and submillimeter astronomy. We first briefly review in this document the astronomical justification and outline a program that should be implemented over the next decade. The basic technical elements including mixers, amplifiers, and spectrometers all exist, but significant development is necessary to allow their effective incorporation into large-format arrays. We discuss these issues and outline a program that will take us to large-format arrays by the end of the decade. We see several intermediate steps that will demonstrate technological progress as well as yielding exciting astronomical results.

## Astronomical Justification

**Cosmic Microwave Background Radiation** The origin, composition and fate of the universe can be studied directly through observations of the cosmic microwave background (CMB)

radiation. Over the last five years, advances in high electron mobility transistors (HEMTs), which are now incorporated into Monolithic Microwave Integrated Circuits (MMICs) – have yielded extraordinary CMB results showing convincingly that the universe is dominated by dark matter (85% of the matter content of the universe) and dark energy (75% of the energy content of the universe), and that the geometry of the universe is Euclidean to within 1%. One of the most pressing challenges in cosmology today is the measurement of the so-called “B-mode” polarization anisotropy of the CMB. At the daunting level of one hundredth of a micro Kelvin, arrays of many hundreds of independent detectors are required to reach the necessary level of sensitivity. Bolometer arrays and MMIC arrays have different systematic errors and both need to be developed to determine whether these can be controlled. Continued development of both technologies is therefore critical for continuation of this fundamental program.

**Nearby Galaxies** Observations of extragalactic spiral galaxies provide an unbiased measure of the distribution of giant molecular clouds (GMCs), their relationship to spiral arms and star formation, and to the mass function of clouds and their stellar progeny. An angular resolution of 7” will be obtained with large mm and submm (single dish) telescopes such as the 100m GBT at 2.6mm, the 50m Large Millimeter Telescope (LMT) at 1.3 mm, and the 25m Cornell Caltech Atacama Telescope (CCAT) at 0.65mm wavelength. The ratio of molecular gas in the arms and interim regions remains an important astrophysical question; it is possible that the interarm regions contain substantial mass in cool material with little structure. Interferometers recover only a fraction of the total flux. Mapping with large-aperture telescopes will bridge the resolution gap to interferometers by revealing the material with low surface brightness and little spatial structure. This would enable a more accurate understanding of GMC mass functions across a sample of galaxy types. Increasing sensitivity to smooth structures also permits a clear understanding of gas flows along bars and across arms, key questions in our understanding of galactic evolution and the starburst phenomenon.

Fig. 1 The location of GMCs in the nearby spiral galaxy M33 are overlaid upon an integrated intensity map of the H I 21 cm line (Engargiola et al., 2003). These observations show that GMCs are formed from large structures of atomic gas, and foreshadow the detailed study of GMC formation that will be made possible by further development of heterodyne arrays. Mapping the full extent of this galaxy would require approximately 27,000 pointings of ALMA array at 345 GHz.

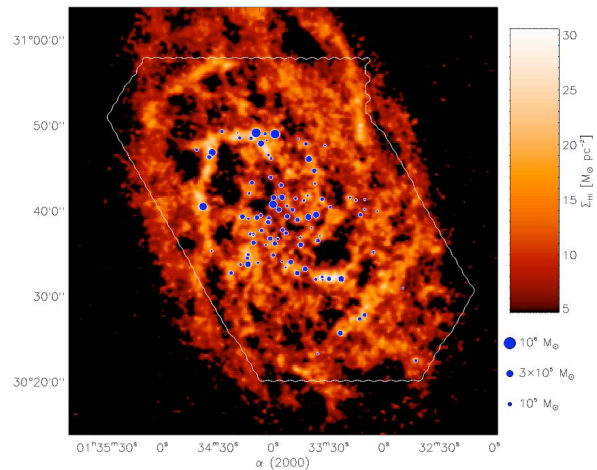

**Star Formation: Dense Cores** Star formation in the Milky Way takes place in molecular clouds that contain upwards of  $10^6 M_{\text{sun}}$  of gas and dust (Scoville et al. 1987). At any given instant, only a few percent of the cloud mass has achieved sufficiently high density to actually form stars (e.g. Johnstone et al. 2004). Understanding why such a small fraction of the cloud mass is contained in dense “cores” is key to determining the dominant physical processes that control the star formation rate in the Galaxy. Toward this goal, extinction maps and submillimeter continuum surveys have measured the size and mass distribution of cores over

entire clouds (Ward-Thompson et al. 2007). Complementary spectroscopic surveys are essential to determine how the dense cores are coupled kinematically to the diffuse molecular material. Such observations will indicate the dynamical state of cores (gravitationally bound or unbound), reveal which cores are in a state of gravitational collapse to form protostars, and determine the spatial scales in which thermal motions dominate over turbulence.

High resolution spectroscopic surveys, however, are available for only a few clouds and in limited molecular species (see Fig. 2). Since dense cores in the nearest molecular clouds are arcminutes in size, and molecular clouds span degrees on the sky, ALMA will be able to map only limited regions and will recover only a portion of the total emission. In contrast, with the advent of focal plane arrays on 30-100 m class single aperture telescopes, entire clouds will be mapped in species that trace the diffuse (e.g.  $^{12}\text{CO}$ ,  $^{13}\text{CO}$ ) and dense (e.g.  $\text{NH}_3$ ,  $\text{N}_2\text{H}^+$ ) molecular material. These observations will provide a complete census of the kinematics of dense cores and their connection to the diffuse material.

Fig. 2 Large-scale image of visual extinction toward the Perseus molecular cloud (Ridge et al. 2006). The contour outlines the extent of the diffuse cloud, and the bright regions indicate the dense cores that have formed. Single dish telescopes equipped with focal plane arrays will map the kinematic structure over the entire cloud to establish the dynamical state of the dense cores.

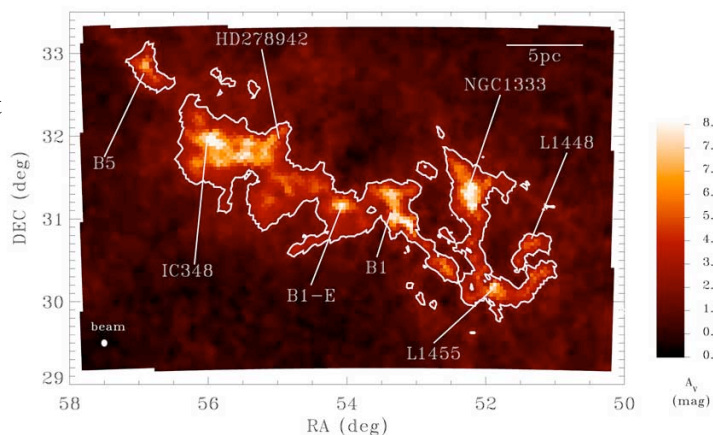

**Star Formation: Outflows** The advent of large-format CCD cameras in the 1990s allowed the discovery of a new class of giant parsec-scale Herbig-Haro (HH) flows from young stellar objects (Reipurth et al 1997). When these HH flows were followed up with available sensitive millimeter and submillimeter receivers and focal-plane arrays, the molecular component of the flows around most YSOs were shown to be much larger in extent. Even towards previously studied regions, when followed up with larger scale mapping (see Fig. 3), molecular outflows are seen to be much larger than the associated optical emission. The spatial extent of outflows from YSOs has a profound effect on their role in determining the fate of the forming solar system and the parent molecular cloud. The energy and momentum deposit of outflows to the molecular cloud remains a controversial and important problem. Without large-scale unbiased surveys of *entire* star-forming molecular clouds for outflow activity, we necessarily underestimate the energy and momentum in outflows and consequently the energy input from young stars to support molecular clouds. Large-format heterodyne array receivers at millimeter and submillimeter wavelengths will enable the mapping of GMCs in CO and its isotopes to identify outflows, and better quantify the dynamic impact of outflows on GMCs.



Fig. 3  $^{12}\text{CO}$  1-0 map towards the L1551 star-forming region in Taurus obtained using the SEQUOIA focal plane array at the FCRAO 14 m telescope (Stojimirovic et al 2006). The blue and red contours indicate blue-shifted and red-shifted gas. The underlying grey scale image shows the optical  $\text{H}\alpha$  data in this region. Various HH objects and YSOs of interest are also shown. Note that the blue-shifted molecular gas is much more extended than the optical emission. The total extent of the mapped outflow is  $30'$  or 1.3 pc

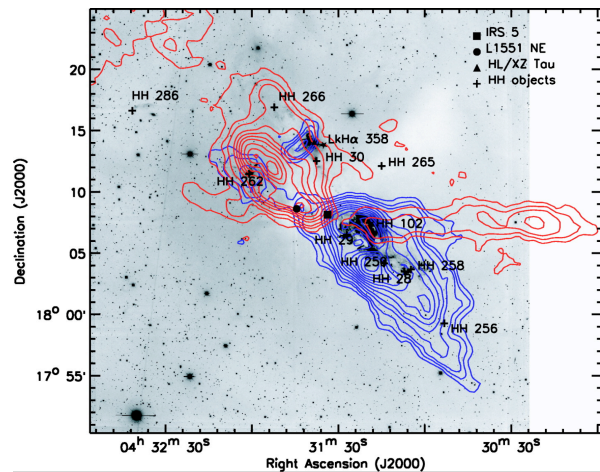

**Astrochemistry** Wide field mapping is required to provide the complete story of the astrophysics and astrochemistry for the majority of interstellar sources. Emission from many interstellar molecules is extended over several, and sometimes hundreds, of arc minutes, with relatively low brightness temperatures. While interferometers are ideal for studying the details of source structure, the large-scale variations give vital information about the conditions in star-forming regions as well as data on variations in elemental as well as molecular abundances. Single dish antennas equipped with focal plane arrays are required to collect these data.

## Array Elements

We consider the frequency range of 30 GHz to 3000 GHz (1 cm to 0.1 mm wavelength). At lower frequencies, element size generally prohibits large-format arrays, while at higher frequencies, the technology for coherent detectors is not sufficiently advanced that large format arrays can be contemplated.

**HEMT MMIC Amplifiers** – Up to frequencies  $\sim 300$  GHz, HEMT MMIC amplifiers will be extremely competitive for arrays, especially due to their large instantaneous bandwidth which can approach 100 GHz. This makes them particularly attractive for galaxy redshift surveys, and unbiased chemical studies. Noise temperatures as low as 25 K have been reported for InP amplifiers in the 80-100 GHz range. Work is underway to further improve HEMT MMIC performance, and to extend frequency range to 300 GHz and beyond. Fig. 3 at right shows performance of a prototype amplifier with reasonable gain over 220 – 280 GHz (chip designed at JPL and fabricated at NGC). Noise performance has not yet been measured, but based on similar components the noise temperature should be  $<100$  K when cooled to 15 K.

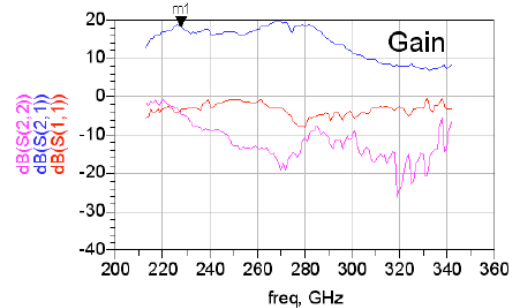

**SIS Mixers** Superconducting –Insulator-Superconductor (SIS) mixers are clearly established as the technology of choice at frequencies up to the maximum set by the superconducting band gap, above which performance deteriorates rapidly. Their performance as well as reproducibility has been accelerated by use in ALMA and Herschel HIFI, illustrating the importance of large-scale programs for technology advances. These characteristics, along with modest local oscillator (LO) requirement make them eminently suitable for focal plane array applications. Works needs

to be continued on balanced mixer design and on sideband separating mixers to maximize spectral coverage and minimize atmospheric noise contribution. An important development will be extension to higher frequency, which will likely require use of new materials with larger band gaps. This issue is the focus of a separate Astro2010 White Paper by A. R. Kerr.

**HEB Mixers** Hot electron bolometer (HEB) mixers are the current solution for frequencies above which SIS mixers are not usable due to bandgap limitations, currently  $\sim 800$  GHz, as discussed above. HEB mixers have the advantage of requiring extremely low local oscillator power, which is especially important if this is produced by frequency multiplication of millimeter-wave sources. However, current realizations suffer from limited IF bandwidth of 3 GHz. This drawback becomes increasingly significant as one moves to higher frequencies, since this corresponds to only 300 km/s at 3 THz frequency. There are currently concepts to significantly increase the IF bandwidth of HEB mixers, and these should be actively pursued to enable operation at shorter wavelength, while preserving the low LO power requirement which is particularly advantageous for focal plane arrays.

**Local Oscillators** become an increasingly critical issue at frequencies above  $\sim 300$  GHz. There is ongoing activity at a number of institutions in this area, and progress is being made. However, for large-format arrays at  $f > 1000$  GHz, continued work is necessary. This will be vital if high performance but LO-demanding SIS mixers become available in this frequency range.

**IF Amplifiers** The use of HEMT MMIC amplifiers for intermediate frequency amplification offers extreme compactness and constructional simplicity, very low noise, and significantly increased bandwidth compared to discrete component amplifiers, InP amplifiers are now available that can cover in excess of 20 GHz bandwidth, and the challenge is to design mixers that can take full advantage of this capability. It is anticipated that further improvements in this technology will occur, but optimization for radio astronomical use in terms of low power and cryogenic operation will require ongoing effort.

**Signal Processing** Backend signal processing encompasses further hardware signal processing after the low-noise front-end amplifiers. For continuum observations, e.g. those in Cosmic Microwave Background imaging and polarimetry, this processing can be as simple as passive filtering and total power detection integrated with the front-end amplifier module. Spectroscopy requires a spectrometer and intermediate frequency processing for each pixel. Fig. 4 here is a guide to bandwidth and resolution requirements for single lines or small line groups likely to be observed with a single-dish imaging system: the total bandwidth varies by about two orders of magnitude and resolution by about four orders of magnitude. The bandwidth requirements scale linearly with input frequency, and are greater for multiple line observations, line surveys or searches, with resolutions appropriately fixed for the different source classes but bandwidths as wide as possible.

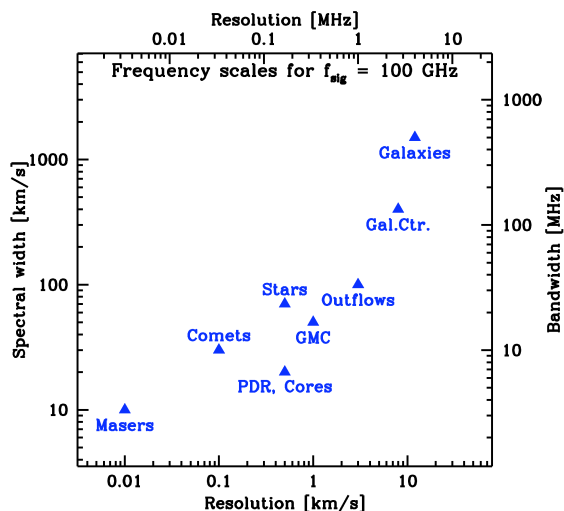

**Analog processing** At microwave and longer millimeter wave frequencies, the availability of many functions in commercial monolithic microwave integrated circuits (MMICs) and of accurate circuit modeling software has enabled fabrication of compact signal processing modules with high reliability and relatively low cost. Conversion of millimeter or submillimeter inputs requires at least one mixing stage, and the development is mixer development for the first downconversion requires concentrated development. The mixers must be simple to integrate, with LO distribution a real issue. Subharmonic MMIC mixers are promising in this application.

**Digital processing** Digital processing will play an increasing role as that technology moves to higher frequencies, with an ultimate goal of replacing nearly all analog components with digitally-synthesized equivalents. Samplers with increasingly large bandwidths and narrow acquisition windows allow direct conversion over increasingly wide bandwidths and high frequencies. Modern digital spectrometers use programmable hardware that can be reconfigured in software. This flexibility is a great advantage for spectroscopy across large fields, since the spectrometer can be reconfigured to match source detections. As an example, a deep extragalactic survey may choose to search for CO emission close to the redshifts of several known object across the whole field, while targeting a handful of pixels that lie on a single objects with known continuum emission to search for a redshift. The current technology of choice is the field-programmable gate array (FPGA). This is likely to continue into the future, as commercial applications drive device capabilities ever higher and power consumption ever lower. One area that needs effort for astronomy is the analog-to-digital converter (or sampler) to obtain the widest possible bandwidths. Samplers with bandwidths of 20 GHz exist for high-speed digital oscilloscopes, but these are neither yet commercially available nor tested for streaming (as opposed to burst) conversions. This critical area for realizing the desired advances in signal processing is described in more detail in an Astro2010 White Paper by David Woody.

## System Integration

Focal plane arrays to date have evolved from single pixel receivers. It is a general rule for modest pixel count arrays, that the performance of an array element cannot be significantly worse than that of the best single pixel. So existing arrays with up to a few tens of elements have naturally been assembled from individual connectorized components, albeit efficiently packed together (see cover page figure). This is sufficiently expensive as well as time consuming, that as one moves to the next level – arrays with many tens of pixels, the approach must be modified, and multi-pixel modules employed, as shown in Fig. 5. An important concern for receivers employing superconducting mixers is that it has been recently demonstrated that broadband, low-noise MMIC amplifiers can be operated at 4 K at power levels of only a few mW per pixel, making it feasible to package IF amplifiers close to mixer elements, with significant gains in performance as well as system packing efficiency.

Fig 5– Eight-element module of Supercam 345 GHz array. The upper portion shows diagonal feedhorn extension block attached to the mixer/IF amplifier block. The lower portion of the figure shows clearly the IF modules and the blind mate connectors, which allow the module to be replaced relatively easily. 8 such modules form the 64-pixel array.

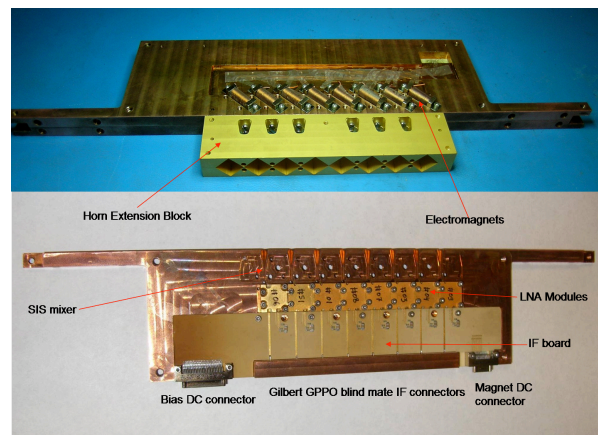



Looking to arrays of hundreds of pixels, hand assembly of complex modules will be unfeasible, and a higher level of integration will be required. One promising avenue is to use modules with multiple chips – for mixers, amplifiers, filters, and other functions, which can be assembled automatically much as commercial circuit boards are populated. An example is shown in Fig. 6.



QUIET's 90 GHz Radiometer on a Chip<sup>®</sup>

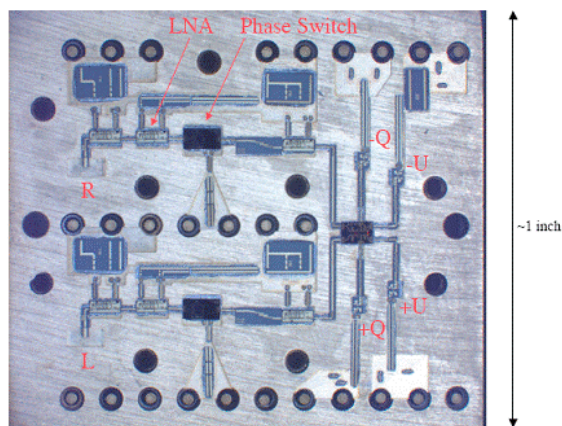
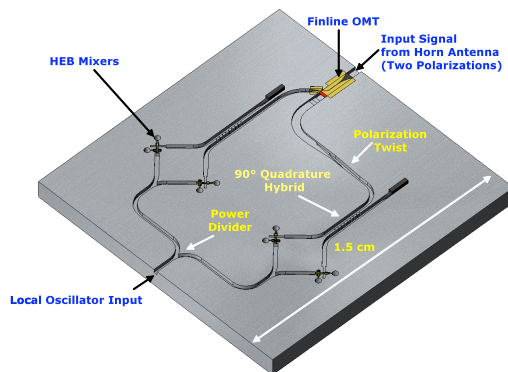

Fig. 6. (left) The QUIET W-band array, built from 91 integrated MMIC pseudocorrelation receiver modules. (right) Dual polarization module operating at 90 GHz Module operating in the 75 – 105 GHz range, with multiple drop in chips providing various functions including amplifiers (2 per channel), phase switches, hybrid junction for signal processing, and detectors for the various Stokes parameters.

The largest-scale arrays envisioned could be made with fewer even more sophisticated multi-function chips. Wafers with complete single pixels or subarrays could potentially be used as building blocks. An example of such a “receiver on a chip” is shown in Fig. 7, in which the RF components of a dual polarization submillimeter heterodyne system employing balanced mixers, are fabricated by micromachining a single block of silicon. This approach is particularly appealing at shorter wavelengths where the dimensions of all components become smaller, making silicon micromachining more practical. The general topic of high-level integration for focal plane arrays is critical for progress and needs intensive support during the next decade.

Fig. 7. The waveguides and some of the RF components of the receiver on a chip are directly micromachined in a silicon block, while a few other passive, and the active components are subsequently bonded in place. This could be extended to include IF amplifiers and other signal processing components as well.



### Focal Plane Array Data & Processing

**Observing Modes** For observations of extended emission with focal plane arrays, on the fly (OTF) mapping is the preferred mode of data collection. OTF maximizes the efficiency of data



collection by minimizing telescope overhead associated with movements of the OTF observing places a much greater demand on the data processing system due to the required readout of the spectrometer channels.

**Data Processing of Focal Plane Array Data** The overproduction of raw data by OTF shifts the burden of integration from the data accumulation buffers in the spectrometers to the post-observing data processing steps in which the irregularly sampled data on the sky are convolved onto a regularly spaced grid. OTF mapping with a heterodyne focal plane array requires the development of a robust pipeline to carry out the necessary processing of the raw data. The increased data rates from large-format arrays raise several challenges that need to be considered in any pipeline development.

**Observer Feedback** A significant challenge in the development of a data pipeline is providing feedback of the data quality to the user for all pixels in the array over the course of an OTF scan or map. Such feedback needs to be very concise to allow a user to visualize a data quality metric for large amounts of data, while informative to allow the user to discard suspect data. The pipeline should have filters to identify and exclude bad data from the final output map/data cube.

**Data Archiving** Archiving of raw data is now an expectation by the astronomical community and funding agencies. While current focal plane array systems can generate 20 Gbytes/day, data rates with the next generation of arrays can be 100-1000 times larger. It is unlikely that a full data archive can be efficiently stored onto hard disks that are instantaneously accessible. Although industry progress in this area will continue, this needs to be closely monitored.

## References

- Elmegreen, B. G. 1989, ApJ 347, 561  
Engargiola, G., Plambeck, R.L., Rosolowsky, E. & Blitz, L. 2003, Ap.J. (Suppl.) 149,343  
Johnstone, D., Di Francesco, J., & Kirk, H. 2004, ApJL, 611, L45  
McCray, R. & Kafatos, M. 1987, ApJ, 317, 190  
Reipurth, B., Bally, J., & Devine, D. 1997, AJ, 114, 2780  
Ridge, N. A., et al. 2006, AJ, 131, 2921  
Scoville, N. Z., Yun, M., Sanders, D. B., Clemens, D. P., & Waller, W. H. 1987, ApJS, 63, 821  
Stojimirovic, I., Narayanan, G., Snell, R.L., & Bally, J. 2006, ApJ, 649, 280  
Ward-Thompson, D., Andre, P., Crutcher, R., Johnstone, D., Onishi, T., & Wilson, C. 2007, Protostars & Planets V, eds. B. Reipurth, D. Jewitt, and K. Keil, (Univ. of Az. Press, Tucson), 33

## Cost and Schedule

Large-format focal plane arrays at millimeter and submillimeter wavelengths are vital for answering a wide range of astrophysical questions relating to the structure of the interstellar medium and its relationship on different scales to star formation. The preceding discussion indicates that different types of tasks are required to enable this important technology in the coming decade. We need to

- Pursue development of elements for arrays,
- Intensify work on system integration issues, and
- Address issues of data rate and implications for processing, storage, and analysis.

These tasks are very diverse, and it will be challenging to pursue them in a coordinated manner, but they all must mature in order to have the astronomical return. A summary of the most important tasks includes the following:

[1] Array Element Development

- Reducing the noise of MMIC HEMT amplifiers to 2-3 times the quantum noise limit
- Extending frequency range of MMIC HEMT amplifiers to 300 GHz and beyond for ultra-broadband array applications
- Increasing the upper frequency limit of SIS mixers to > 1000 GHz
- Developing local oscillator sources at frequencies above 300 GHz including multipliers, power amplifier drivers and quantum cascade lasers
- Reducing the power consumption of MMIC amplifiers
- Applying advances in digital signal to the needs of astronomical spectroscopy

[2] System Integration

- Developing new MMIC designs to enhance integrated array element performance
- Designing mass producible feed arrays and OMTs, and cryogenic interconnects
- High level integration for short wavelength millimeter and submillimeter receivers

[3] Data Processing and Archiving

To support [1], groups around the country need to have support for tasks ranging from studies of new superconducting materials to development of improved fabrication techniques for ultrascale structures and MMIC amplifiers. Some of this work needs to be carried out in collaboration with industry, and research-industrial partnerships should be encouraged. It should be recognized that this work cannot be carried out in the context of a specific system with rigid cost and schedule constraints, but must be supported at a technical infrastructure level.

Topic [2] is essential for progress in focal plane array systems. Development of much more highly integrated mm and submm array frontends is essential to surpass the 100-element threshold. A number of good possibilities for this exist, but they are relatively expensive to develop. Some of the work that needs to be carried out will have “visible” results, but some, for example adapting miniature cables and connectors for RF and IF signal transmission, could be considered mundane were this work not essential for development of large-format arrays. This disparity should be recognized and mechanisms for supporting all required technology development should be found.

The development of software and hardware for [3] could be effectively done on a community basis inasmuch as many of the problems of array data processing will be common among instruments. Some progress in this area is occurring already, but this needs to be nurtured both by supporting individuals developing software for future arrays and for sharing developments. Almost all major institutions developing mm and submm systems anticipate being involved with focal plane arrays, and consequently share an interest in this task.

We recognize that some of these tasks overlap with proposals in other submissions to Astro2010, particularly elements of [1] above. For the work on coherent focal plane arrays, we recommend the following budgets for the above tasks during the decade ahead.

Task	Budget (\$M)
[1] focal plane array element development	20.
[2] system integration	10.
[3] data acquisition, analysis, and archiving	5.

In addition to this basic, ongoing support, it is appropriate to envision a number of test and demonstration arrays that would drive the technology development, demonstrate maturity of critical technologies, and also produce interesting science. We envision that two arrays in the mm range, and two in submm range spread throughout the decade, would provide this impetus. The mechanism for selection and funding is certainly not clear at this point, but this would presumably be shared among agencies, as submm arrays would likely be on suborbital platforms. We estimate a cost for two earlier arrays at \$5M each and the two later (and presumably larger-format) arrays at \$10M each.

[4] demonstration arrays	30.
Total support requested for mm and submm focal plane array development	65.

### Summary and Recommendations

Focal plane arrays at millimeter and submillimeter wavelengths address a variety of important astrophysical problem, particularly in the area of star formation. To exploit effectively existing and anticipated ground-, suborbital, and space-based facilities will require development of arrays with at least an order of magnitude more pixels with greater sensitivity operating over a much greater frequency range than currently available. We thus recommend

[1] pushing the development of array elements including amplifiers, mixers, local oscillators, and spectrometers; to enhance performance and allow operation over the full millimeter and submillimeter frequency range;

[2] investing in system integration, which is of critical importance not only because of the prohibitive difficult of assembling an array using individual pixel technology, but because the problem of interconnections between the components and the requirement of individual control (e.g. biasing) will get completely out of hand. This is probably the single most important area for investment in order to enable progress towards large-scale focal plane coherent arrays;

[3] including support for the development of computer systems, software and data storage systems for large-format focal plane arrays, which need focused study in a timely manner to ensure that the output from the array systems developed can be effectively used by the astronomical community.

We recommend a funding level of \$65M for these activities over the coming decade.

The work described in this report was performed at the Jet Propulsion Laboratory, California Institute of Technology, under a contract with the National Aeronautics and Space Administration. © 2009. All rights reserved